

DS 2800/9000

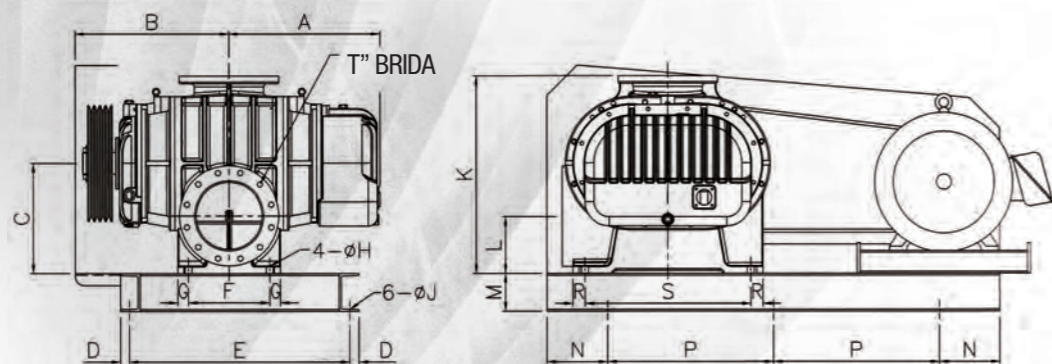

MODELO	A	B	C	D	E	F	G	H	J	K	L	M	N	P	R	S	T	Peso
DS 2800	515	495	363	30	730	270	35	23	19	650	190	125	200	550	40	550	8	720
DS 4500	605	595	388	30	730	460	35	23	19	675	225	125	200	550	40	550	10	913
DS 9000	900	805	500	40	1120	650	65	27	24	875	250	200	200	800	55	620	12	2010

Dimensiones: mm / Peso: kg

DS 17000

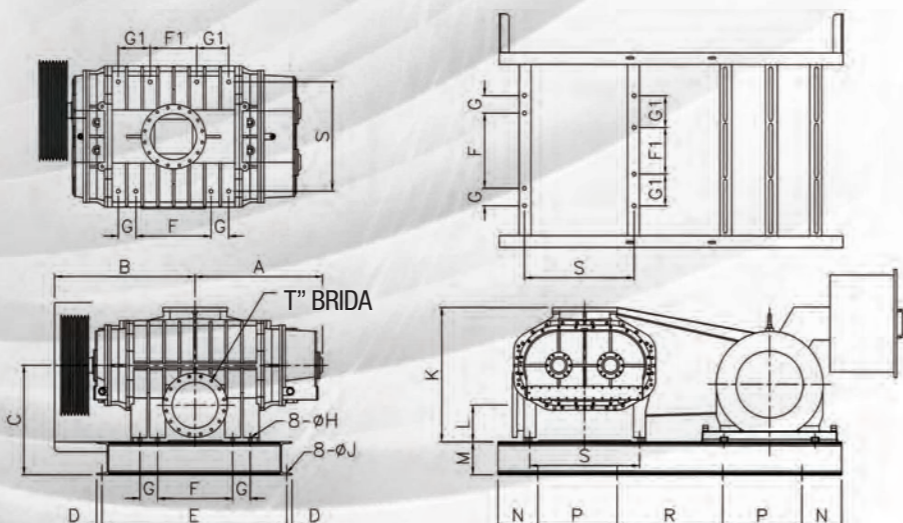

MODELO	A	B	C	D	E	F	F1	G	G1	H	J	K	L	M	N	P	R	S	T	Peso
DS 17000	965	1065	830	40	1400	570	354	133	35	241	24	1020	278	250	300	600	800	830	14	4100

Dimensiones: mm / Peso: kg

DS 22000

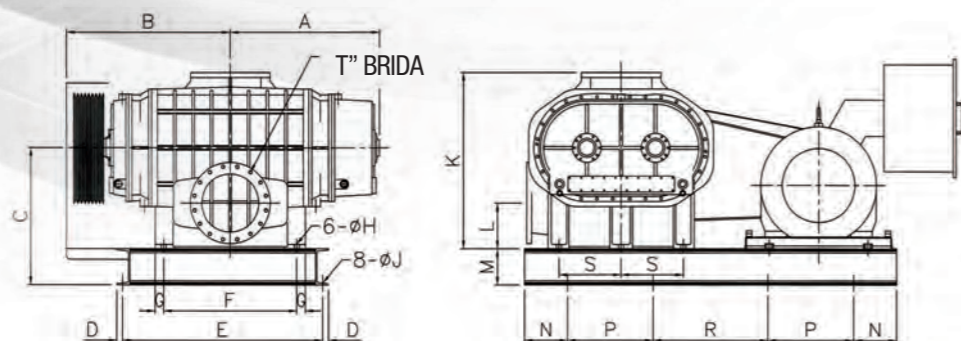

MODELO	A	B	C	D	E	F	G	H	J	K	L	M	N	P	R	S	T	Peso
DS 22000	1043	1147	945	40	1400	930	60	35	24	1215	315	250	300	600	800	435	16	4650

Dimensiones: mm / Peso: kg

SOPLADORES TRILOBULARES TIPO ROOTS



ESPECIFICACIONES:

- Capacidad: 30 a 21600 m³/h
- Presión: 100 a 800 mbar
- Vacío: -100 a -500 mbar
- Diámetro: 1.5" a 16"



Diagonal 154 (Rivadavia) N° 5945 - B1657COX - Loma Hermosa (San Martín) - Buenos Aires - Argentina
 Tel.: (54 11) 4769-1029 / 8666 - Fax: (54 11) 4841-0966 - e-mail: sopladores@dosivac.com - www.dosivac.com

DOSIVAC

SOPLADORES DE AIRE Y BOMBAS DE VACÍO - TIPO ROOTS TRILOBULARES ROTATIVOS

Sopladores DOSIVAC tipo root de desplazamiento positivo trilobulares, logrando con innovador desarrollo un equipo de alta eficiencia que prolonga la vida útil de rodamientos, bajando el nivel de ruido, vibraciones y consumo energético. Apoyados en nuestra experiencia desarrollada desde 1982 con productos de alta calidad, tecnología de última generación y servicio de asesoramiento y post venta.

CARACTERÍSTICAS

Trilobular: brindando mayor rigidez de rotores, disminuye las vibraciones y los esfuerzos sobre la instalación en comparación con un soplador bilobular. Además del diseño de descarga horizontal que baja aún más el nivel de ruido.

Aire limpio libre de aceite

Flujo de aire y presión estable

Construcción simple y de fácil mantenimiento

Rodamientos y engranajes lubricados por aceite en ambos lados del soplador.

ALGUNAS APLICACIONES:

- Aireación en tratamiento de aguas y efluentes
- Agitación por aire
- Transporte neumático por presión y vacío.
- Metalización, empacadoras por vacío.

UTILIZADOS EN INDUSTRIA:

- Alimenticia
- Construcción
- Petroquímica
- Textil
- Química
- Metalúrgica
- Minera entre otras

Sellos:

bajo desgaste, sellos laberínticos asegurando eficiencia y prolongada vida útil

Ejes:

de acero aleado que permite operar bajo alta exigencia.

Rotores:

fabricados en hierro fundido ó acero inoxidable con un diseño que otorga alta resistencia y máxima vida útil por maquinaria CNC y 3D que asegura altísimo rendimiento.

Cuerpo:

en hierro fundido, con diseño de precisión dando rigidez y alta disipación de calor.

Rodamientos:

aptos para soportar operación continua a presión máxima y alta vida útil.

Engranajes:

forjados y endurecidos con diseño que reduce vibraciones y asegura una suave sincronización entre rotores para eficiente operación.



TABLA DE SELECCIÓN DE SOPLADORES TRABAJANDO POR PRESIÓN

Los valores indicados corresponden a presión atmosférica normal P: 1013 mbar y temperatura de admisión de aire T: 20 °C con una tolerancia de +/- 5%

MOD	RPM	100(mbar)		200(mbar)		300(mbar)		400(mbar)		500(mbar)		600(mbar)		700(mbar)		800(mbar)	
		Qs (m³/h)	P (HP)	Qs (m³/h)	P (HP)	Qs (m³/h)	P (HP)	Qs (m³/h)	P (HP)	Qs (m³/h)	P (HP)	Qs (m³/h)	P (HP)	Qs (m³/h)	P (HP)	Qs (m³/h)	P (HP)
DS 60	1650	36	0.3	34	0.5	32	0.7	31	0.9	29	1.1	29	1.3				
	1800	41	0.3	38	0.5	37	0.8	35	1.0	34	1.2	33	1.4				
	1950	45	0.3	43	0.6	41	0.8	40	1.1	38	1.3	37	1.5				
	2100	50	0.3	47	0.6	46	0.9	44	1.2	43	1.4	42	1.6				
	2250	54	0.3	52	0.7	50	1.0	49	1.2	47	1.5	46	1.7				
	2400	58	0.4	56	0.7	55	1.0	53	1.3	52	1.6	51	1.8				
	2550	63	0.4	61	0.8	59	1.1	58	1.4	56	1.7	55	1.9				
DS 150	850	59	0.5	47	1.1	38	1.6	30	2.0	23	2.5	17	2.9	13	3.3	9	3.7
	1000	79	0.6	67	1.3	58	1.8	49	2.4	42	2.9	37	3.4	32	3.9	28	4.3
	1150	98	0.8	86	1.4	77	2.1	69	2.7	61	3.3	56	3.9	52	4.5	47	5.0
	1300	117	0.8	106	1.6	97	2.4	88	3.1	80	3.8	75	4.4	71	5.0	67	5.6
	1450	136	0.9	125	1.8	116	2.7	107	3.4	100	4.2	95	4.9	90	5.6	86	6.3
	1600	156	1.0	144	2.0	135	2.9	127	3.8	119	4.6	114	5.4	109	6.2	106	6.9
	1750	175	1.1	163	2.2	154	3.2	146	4.2	139	5.1	133	5.9	128	6.8	125	7.6
DS 300	850	124	0.8	113	1.6	103	2.4	93	3.1	85	3.7	77	4.4	71	5.0	65	5.6
	1000	155	1.0	145	1.9	133	2.8	124	3.6	116	4.4	109	5.1	103	5.9	96	6.5
	1150	186	1.1	176	2.2	164	3.2	155	4.1	147	5.1	140	5.9	133	6.7	127	7.5
	1300	217	1.3	207	2.5	196	3.6	186	4.7	178	5.7	170	6.7	164	7.6	158	8.5
	1450	248	1.4	238	2.8	226	4.0	217	5.2	209	6.4	202	7.5	196	8.5	189	9.5
	1600	279	1.6	269	3.1	257	4.5	248	5.8	240	7.0	233	8.2	226	9.4	220	10.5
	1750	310	1.7	300	3.3	289	4.9	279	6.3	271	7.7	263	9.0	257	10.3	251	11.5
DS 500	850	194	1.5	172	2.9	152	4.1	134	5.3	117	6.3	102	7.3	89	8.2	77	9.1
	1000	248	1.8	226	3.4	206	4.9	188	6.2	171	7.5	156	8.6	143	9.7	131	10.7
	1150	302	2.0	280	3.9	260	5.6	242	7.1	225	8.6	210	9.9	197	11.2	185	12.3
	1300	356	2.3	334	4.4	314	6.3	296	8.1	279	9.7	264	11.2	251	12.6	239	13.9
	1450	410	2.6	388	4.9	368	7.0	350	9.0	333	10.8	318	12.5	305	14.1	293	15.5
	1600	464	2.8	464	5.4	422	7.8	404	9.9	387	11.9	372	13.8	359	15.5	347	17.1
	1750	518	3.1	496	5.9	476	8.5	458	10.9	441	13.1	426	15.1	413	17.0	401	18.7
DS 700	850	348	2.1	311	4.0	279	5.8	250	7.4	224	8.9	202	10.3	182	11.6	164	12.8
	1000	424	2.5	387	4.7	355	6.8	325	8.7	300	10.5	277	12.1	257	13.6	240	15.0
	1150	499	2.8	463	5.4	430	7.8	401	10.0	376	12.0	353	13.9	333	15.6	316	17.2
	1300	575	3.2	538	6.1	506	8.8	476	11.3	451	13.6	428	15.7	409	17.7	391	19.5
	1450	650	3.6	614	6.9	581	9.9	552	12.6	527	15.2	504	17.5	484	19.7	467	21.8
	1600	726	4.0	689	7.6	657	10.9	628	13.9	602	16.7	580	19.3	560	21.8	542	24.0
	1750	802	4.3	765	8.3	733	11.9	703	15.2	678	18.3	655	21.1	635	23.8	618	26.2
DS 1300	750	617	3.5	565	6.7	517	9.6	473	12.2	435	14.7	400	17.0	367	19.1	339	21.1
	900	761	4.2	709	8.0	661	11.5	617	14.7	578	17.6	543	20.4	511	22.9	482	25.3
	1050	905	4.9	852	9.3	805	13.4	760	17.1	722	20.6	686	23.8	654	26.8	626	29.6
	1200	1049	5.6	996	10.6	948	15.3	904	19.6	866	23.5	830	27.2	797	30.6	770	33.8
	1350	1192	6.2	1139	12.0	1091	17.2	1048	22.0	1009	26.5	974	30.6	941	34.4	914	38.0
	1500	1336	6.9	1283	13.3	1235	19.1	1191	24.5	1153	29.4	1118	34.0	1085	38.2	1057	42.2
	1650	1480	7.6	1427	14.6	1379	21.0	1335	26.9	1297	32.4	1261	37.4	1229	42.1	1201	46.4

TABLA DE SELECCIÓN DE SOPLADORES TRABAJANDO POR PRESIÓN

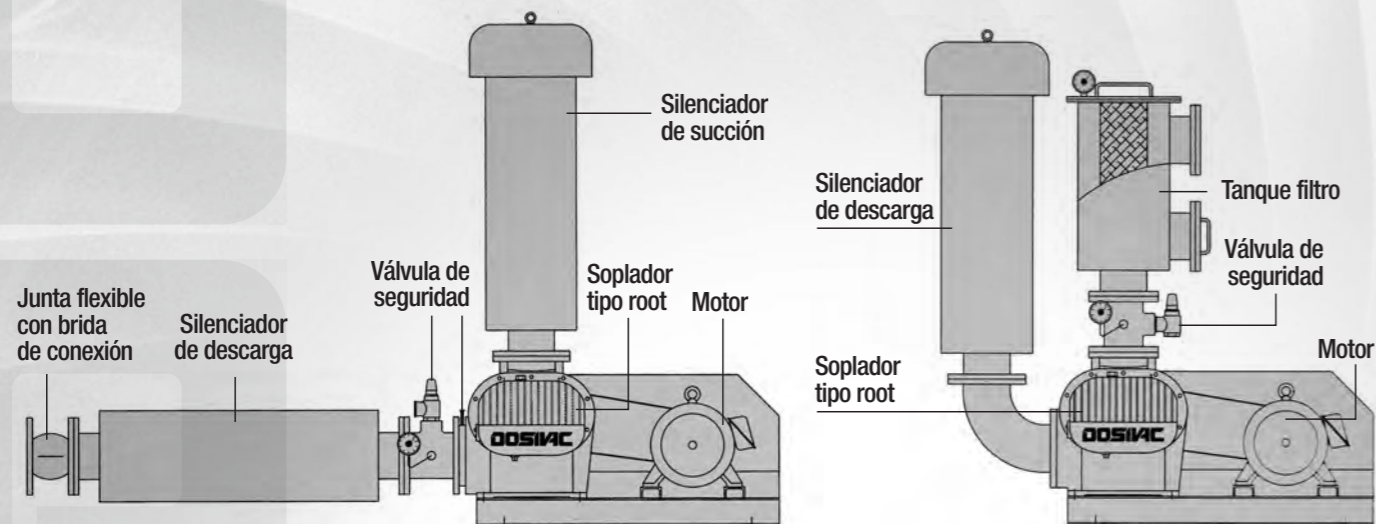
Los valores indicados corresponden a presión atmosférica normal P: 1013 mbar y temperatura de admisión de aire T: 20 °C con una tolerancia de +/- 5%

MOD	RPM	100(mbar)		200(mbar)		300(mbar)		400(mbar)		500(mbar)		600(mbar)		700(mbar)		800(mbar)	
		Qs (m³/h)	P (HP)	Qs (m³/h)	P (HP)	Qs (m³/h)	P (HP)	Qs (m³/h)	P (HP)	Qs (m³/h)	P (HP)	Qs (m³/h)	P (HP)	Qs (m³/h)	P (HP)	Qs (m³/h)	P (HP)
DS 1800	750	799	4.5	757	8.6	719	12.3	684	15.8	652	19.0	623	21.9	600	24.7	577	27.2
	900	984	5.4	942	10.3	904	14.8	869	18.9	837	22.8	809	26.3	785	29.6	762	32.7
	1050	1169	6.3	1127	12.0	1089	17.2	1055	22.1	1022	26.6	994	30.7	971	34.5	947	38.1
	1200	1355	7.2	1313	13.7	1274	19.7	1240	25.2	1208	30.3	1179	35.1	1156	39.5	1132	43.5
	1350	1540	8.1	1498	15.4	1460	22.2	1425	28.4	1393	34.1	1364	39.5	1341	44.4	1318	49.0
	1500	1725	9.0	1683	17.1	1645	24.6	1610	31.5	1578	37.9	1550	43.8	1526	49.3	1503	54.4
	1650	1910	9.9	1868	18.9	1830	27.1	1795	34.7	1763	41.7	1735	48.2	1711	54.3	1688	59.9
DS 2800	600	1021	6.5	957	12.4	902	17.9	853	22.9	812	27.5	776	31.8	744	35.8	719	39.5
	750	1361	8.1	1297	15.5	1243	22.3	1193	28.6	1152	34.4	1116	39.7	1084	44.7	1059	49.4
	900	1701	9.7	1637	18.6	1583	26.8	1533	34.3	1492	41.3	1456	47.7	1424	53.7	1399	59.2
	1050	2041	11.4	1978	21.8	1923	31.3	1873	40.0	1832	48.1	1796	55.6	1765	62.6	1739	69.1
	1200	2381	13.0	2318	24.8	2263	35.7	2213	45.8	2173	55.0	2137	63.6	2105	71.6	2080	79.0
	1350	2722	14.6	2658	28.0	2603	40.2	2554	51.5	2513	61.9	2477	71.5	2445	80.5	2420	88.9
	1500	3062	16.2	2998	31.1	2944	44.7	2894	57.2	2853	68.8	2817	79.5	2785	89.5	2760	98.8
DS 4500	600	1663	9.9	1573	19.0	1493	27.3	1421	34.9	1355	42.0	1296	48.6	1244	54.7	1199	60.3
	750	2183	12.4	2093	23.7	2133	34.1	1940	43.7	1874	52.5	1816	60.7	1763	68.3	1718	75.4
	900	2703	14.9	2612	28.5	2533	40.9	2460	52.4	2395	63.0	2335	72.9	2284	82.0	2239	90.5
	1050	3223	17.4	3133	33.2	3053	47.8	2980	61.2	2914	73.5	2855	85.0	2803	95.7	2758	105.6
	1200	3742	19.8	3652	38.0	3572	54.6	3500	69.9	3434	84.0	3375	97.2	3323	109.3	3278	120.7
	1350	4262	22.3	4172	42.7	4092	61.4	4019	78.6	3953	94.6	3895	109.3	3842	123.0	3797	135.7
	1500	4782	24.8	4691	47.5	4612	68.2	4539	87.4	4474	105.1	4414	121.4	4363	136.6	4318	150.9
DS 9000	600	3536	19.4	3329	34.7	3223	49.9	3122	64.0	3029	78.9	2956	92.4	2855	106.6	2802	119.1
	750	4537	24.2	4330	43.4	4223	62.4	4123	80.0	4030	98.6	3956	115.5	3856	133.2	3828	148.9
	900	5538	29.1	5331	52.1	5224	74.9	5124	95.9	5030	118.3	4957	138.5	4857	159.8	4804	178.8
	1050	6540	33.9	6330	60.7	6222	87.4	6126	111.9	6030	138.0	5958	161.6	5858	186.5	5804	208.5
	1200	7542	37.9	7332	69.4	7202	99.9	7128	127.9	7032	157.8	6960	184.8	6858	213.2	6804	238.3
	1350	8538	43.6	8334	78.1	8226	112.3	8124	143.9	8034	177.5	7962	207.9	7860	239.8	7806	268.1
	1500	9540	48.4	9336	86.8	9228	124.8	9126	160.0	9036	197.3	8958	230.9	8862	266.5	8808	297.8
DS 17000	600	8298	43.3	7986	77.8	7740	111.9	7512	147.0	7314	179.8	7146	215.0	6978	245.0	6810	284.7
	700	9828	50.6	9516	90.7	9270	130.6	9042	171.5	8844	209.7	8676	250.9	8508	285.9	8340	332.2
	800	11358	57.8	11046	104.2	10800	149.3	10572	196.1	10374	239.8	10206	286.7	10038	326.8	9870	379.6
	900	12888	65.0	12576	116.7	12330	167.9	12102	220.6	11904	269.7	11736	322.5	11568	367.6	11400	427.1
	1000	14418	72.2	14106	129.6	13860	186.5	13632	245.0	13434	299.6	13266	358.3	13098	408.5	12930	474.6
	1100	15948	79.4	15636	142.5	15390	205.2	15162	269.5	14964	329.6	14796	394.3	14628	449.2	14460	521.9
	1200	17478	86.7	17166	155.6	16920	223.9	16692	294.1	16494	359.5	16326	430.1	16158	490.1	15990	569.4
DS 22000	600	14178	71.4	13818	128.3	13530	184.7	13278	242.5	13056	296.5	12846	354.6	12678	404.2	12528	469.5
	650	15444	77.4	15084	138.9	14790	199.9	14538	262.7	14316	321.2	14112	384.2	13938	437.8	13788	508.6
	700	16704	83.4	16344	149.7	16050	215.4	15798	282.8	15576	345.8	15372	413.7	15204	471.5	15048	547.8
	750	17964	89.3	17604	160.4	17316	230.8	17064	303.1	16842	370.7	16632	443.2	16464	505.2	16314	587.0
	800	19224	95.3	18864	171.0	18576	246.2	18324	323.3	18102	395.3	17892	472.8	17724	538.8	17574	626.0
	850	20490	101.2	20130	181.7	19836	261.5	19584	343.4	19362	420.0	19158	502.3	18984	572.5	18834	665.1
	900	21750	107.2	21390	192.4	21096	276.9	20844	363.7	20622	444.7	20418	532.0	20250	606.1	20100	704.3

TABLA DE SELECCIÓN DE SOPLADORES TRABAJANDO POR VACÍO

Los valores indicados corresponden a presión atmosférica normal P: 1013 mbar y temperatura de admisión de aire T: 20 °C con una tolerancia de +/- 5%

MOD	RPM	-100(mbar)		-200(mbar)		-250(mbar)		-300(mbar)		-350(mbar)		-400(mbar)		-500(mbar)	
		Qs (m³/h)	P (HP)	Qs (m³/h)	P (HP)	Qs (m³/h)	P (HP)	Qs (m³/h)	P (HP)	Qs (m³/h)	P (HP)	Qs (m³/h)	P (HP)	Qs (m³/h)	P (HP)
DSV 60	1650	36	0.3	35	0.5	33	0.6	31	0.7	30	0.8	29	0.8		
	1800	41	0.3	39	0.5	37	0.6	35	0.7	35	0.8	33	0.9		
	1950	45	0.3	43	0.6	42	0.7	40	0.8	39	0.9	37	1.0		
	2100	50	0.3	48	0.6	46	0.7	44	0.9	43	1.0	42	1.1		
	2250	54	0.3	52	0.7	51	0.8	49	0.9	48	1.0	46	1.1		
	2400	58	0.4	57	0.7	55	0.8	53	1.0	52	1.1	51	1.2		
	2550	63	0.4	61	0.8	59	0.9	58	1.0	57	1.2	55	1.3		
DSV 150	850	59	0.5	49	1.1	43	1.3	37	1.6	31	1.8	22	2.0	16	2.2
	1000	79	0.6	68	1.3	62	1.6	56	1.8	50	2.1	41	2.4	35	2.6
	1150	98	0.8	88	1.4	82	1.8	75	2.1	69	2.4	61	2.7	55	3.0
	1300	117	0.8	107	1.6	101	2.0	95	2.4	89	2.7	80	3.1	74	3.4
	1450	136	0.9	127	1.8	121	2.3	114	2.7	108	3.1	99	3.4	94	3.8
	1600	156	1.0	146	2.0	140	2.5	133	2.9	127	3.4	118	3.8	113	4.2
	1750	175	1.1	165	2.2	159	2.7	152	3.2	146	3.7	137	4.2	132	4.6
DSV 300	850	125	0.9	115	1.7	108	2.1	101	2.5	93	2.9	85	3.2	76	3.6
	1000	156	1.0	146	2.0	139	2.5	131	3.0	124	3.4	115	3.8	106	4.2
	1150	187	1.2	177	2.3	170	2.9	163	3.4	155	3.9	146	4.4	133	4.9
	1300	218	1.4	208	2.6	201	3.2	194	3.8	186	4.4	178	5.0	169	5.5
	1450	249	1.5	239	2.9	232	3.6	224	4.3	217	4.9	208	5.5	199	6.2
	1600	280	1.7	270	3.2	263	4.0	256	4.7	248	5.4	239	6.1	230	6.8
	1750	311	1.8	301	3.5	294	4.4	287	5.2	279	5.9	271	6.7	262	7.4
DSV 500	850	194	1.5	170	2.9	156	3.5	142	4.1	126	4.7	110	5.3	92	5.8
	1000	248	1.8	224	3.4	210	4.1	196	4.9	180	5.6	164	6.2	146	6.9
	1150	302	2.0	278	3.9	264	4.7	250	5.6	234	6.4	218	7.1	200	7.9
	1300	356	2.3	332	4.4	318	5.4	304	6.3	288	7.2	272	8.1	254	8.9
	1450	410	2.6	386	4.9	372	6.0	358	7.0	342	8.0	326	9.0	308	9.9
	1600	464	2.8	440	5.4	426	6.6	412	7.8	396	8.9	380	9.9	362	11.0
	1750	518	3.1	494	5.9	480	7.2	466	8.5	450	9.7	434	10.9	416	12.0
DSV 700	850	348	2.1	311	4.0	291	4.9	269	5.8	245	6.6	220	7.4	193	8.2
	1000	424	2.5	387	4.7	367	5.8	344	6.8	321	7.8	296	8.7	269	9.6
	1150	499	2.8	463	5.4	442	6.7	420	7.8	397	8.9	371	10.0	344	11.0
	1300	575	3.2	538	6.1	518	7.5	496	8.8	472	10.1	447	11.3	420	12.5
	1450	650	3.6	614	6.9	593	8.4	571	9.9	548	11.3	523	12.6	496	13.9
	1600	726	4.0	689	7.6	669	9.3	647	10.9	623	12.4	598	13.9	571	15.4
	1750	802	4.3	765	8.3	745	10.1	722	11.9	699	13.6	674	15.2	647	16.8
DSV 1300	750	617	3.5	558	6.7	527	8.1	492	9.6	457	10.9	421	12.2	339	

TABLA DE SELECCIÓN DE SOPLADORES TRABAJANDO POR VACÍO

Los valores indicados corresponden a presión atmosférica normal P: 1013 mbar y temperatura de admisión de aire T: 20 °C con una tolerancia de +/- 5%

MOD	RPM	-100(mbar)		-200(mbar)		-250(mbar)		-300(mbar)		-350(mbar)		-400(mbar)		-500(mbar)	
		Qs (m³/h)	P (HP)	Qs (m³/h)	P (HP)	Qs (m³/h)	P (HP)	Qs (m³/h)	P (HP)	Qs (m³/h)	P (HP)	Qs (m³/h)	P (HP)	Qs (m³/h)	P (HP)
DSV 1800	750	799	4.5	753	8.6	728	10.5	701	12.3	672	14.1	641	15.8	573	19.0
	900	984	5.4	938	10.3	914	12.6	887	14.8	857	16.9	826	18.9	758	22.8
	1050	1169	6.3	1124	12.0	1099	14.7	1072	17.2	1042	19.7	1012	22.1	943	26.6
	1200	1355	7.2	1309	13.7	1284	16.8	1257	19.7	1228	22.5	1196	25.2	1129	30.3
	1350	1540	8.1	1494	15.4	1469	18.9	1442	22.2	1412	25.3	1382	28.4	1314	34.1
	1500	1725	9.0	1679	17.1	1655	21.0	1627	24.6	1598	28.2	1567	31.5	1499	37.9
1650	1910	9.9	1865	18.9	1840	23.1	1813	27.1	1783	31.0	1752	34.7	1684	41.7	
DSV 2800	600	1021	6.5	959	12.4	925	15.2	892	17.9	853	20.4	809	22.9	719	27.5
	750	1361	8.1	1300	15.5	1265	19.0	1232	22.2	1193	25.5	1150	28.6	1059	34.4
	900	1701	9.7	1640	18.6	1606	22.8	1572	26.8	1533	30.6	1490	34.3	1399	41.3
	1050	2041	11.4	1980	21.8	1947	26.6	1912	31.3	1879	35.7	1830	40.0	1739	48.1
	1200	2381	13.0	2320	24.8	2286	30.4	2252	35.7	2213	40.8	2170	45.8	2080	55.0
	1350	2722	14.6	2660	28.0	2626	34.2	2593	40.2	2554	45.9	2510	51.5	2420	61.9
1500	3062	16.2	3001	31.1	2966	38.0	2933	44.7	2894	51.1	2851	57.2	2760	68.8	
DSV 4500	600	1663	9.9	1573	19.0	1521	23.2	1466	27.3	1407	31.2	1341	34.9	1199	42.0
	750	2183	12.4	2093	23.7	2041	29.0	1985	34.1	1927	39.0	1861	43.7	1718	52.5
	900	2703	14.9	2612	28.5	2561	34.8	2505	40.9	2446	46.8	2380	52.4	2239	63.0
	1050	3223	17.4	3133	33.2	3080	40.6	3025	47.8	2966	54.6	2900	61.2	2758	73.5
	1200	3742	19.8	3652	38.0	3600	46.5	3545	54.6	3486	62.4	3420	69.9	3278	84.0
	1350	4262	22.3	4172	42.7	4120	52.3	4064	61.4	4006	70.2	3940	78.6	3797	94.6
1500	4782	24.8	4691	47.5	4640	58.1	4584	68.2	4525	78.0	4459	87.4	4318	105.1	
DSV 9000	600	3536	19.1	3376	36.6	3289	44.7	3189	52.6	3089	60.1	2983	67.3	2742	80.9
	750	4537	23.9	4377	45.7	4290	55.9	4190	65.7	4090	75.1	3983	84.1	3803	101.1
	900	5538	28.7	5378	54.8	5291	67.1	5191	78.8	5091	90.1	4984	100.9	4744	121.4
	1050	6540	33.4	6378	64.0	6294	78.3	6192	92.0	6090	105.1	5985	117.8	5744	141.6
	1200	7542	38.2	7380	73.1	7290	89.4	7194	105.1	7092	120.2	6984	134.6	6744	161.9
	1350	8538	43.0	8382	82.2	8292	100.6	8196	118.2	8094	135.2	7986	151.4	7746	182.1
1500	9540	47.8	9378	91.4	9294	111.8	9192	131.4	9096	150.2	8988	168.2	8748	202.2	
DS 17000	600	8298	43.9	7938	76.9	7710	92.7	7482	111.2	7284	126.3	7074	141.9	6474	176.6
	700	9828	51.9	9468	89.7	9240	108.2	9012	129.8	8814	147.4	8604	165.5	8004	206.1
	800	11346	58.5	10998	102.5	10770	123.6	10542	148.3	10344	168.4	10134	189.2	9534	235.6
	900	12876	65.8	12528	115.3	12300	139.1	12072	166.8	11874	189.3	11664	212.8	11064	265.0
	1000	14406	73.1	14058	128.1	13830	154.5	13602	185.3	13404	210.4	13194	236.4	12594	294.5
	1100	15936	80.4	15588	140.9	15360	170.0	15132	204.0	14934	231.5	14724	260.0	14124	323.9
1200	17466	87.8	17118	153.7	16890	185.5	16662	222.5	16464	252.5	16254	283.8	15654	353.4	
DS 22000	600	14178	71.1	13698	128.4	13476	157.3	13170	184.9	12996	213.2	12744	242.1	12210	299.0
	650	15444	77.0	14964	139.2	14736	170.4	14430	200.3	14256	231.1	14004	262.2	13476	324.0
	700	16704	82.9	16224	149.8	15996	183.4	15696	215.8	15516	248.8	15264	282.4	14736	348.9
	750	17964	88.8	17484	160.5	17256	196.6	16956	231.2	16782	266.6	16524	302.5	15996	373.9
	800	19224	94.7	18750	171.2	18522	209.7	18216	246.6	18042	284.3	17790	322.8	17256	398.7
	850	20490	100.7	20010	182.0	19782	222.9	19476	262.0	19302	302.1	19050	342.9	18522	423.6
900	21750	106.6	21270	192.7	21042	235.9	20742	277.5	20562	319.8	20310	363.0	19782	448.6	

curva de rendimiento de la presión

DS 60

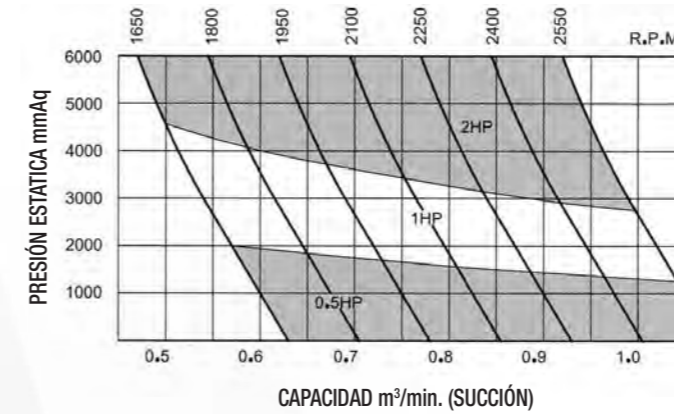

DS 500

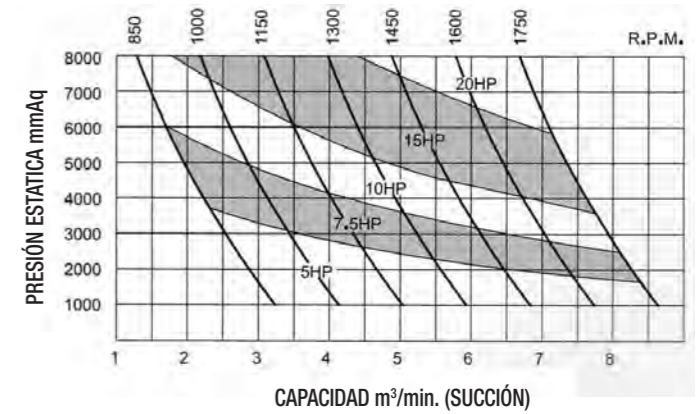

DS 150

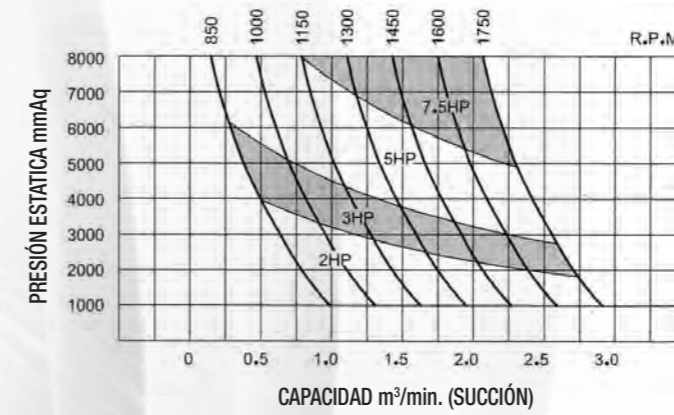

DS 700

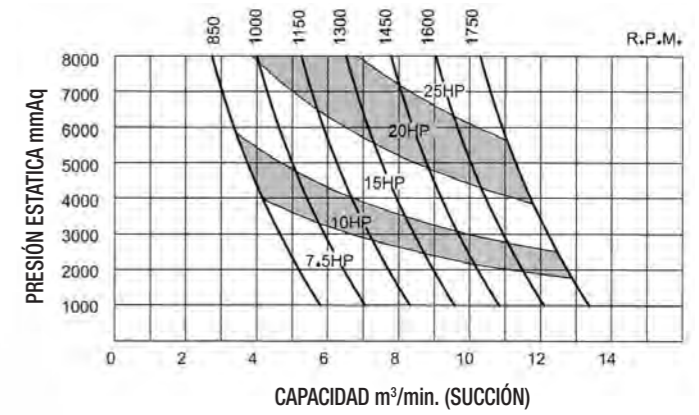

DS 300

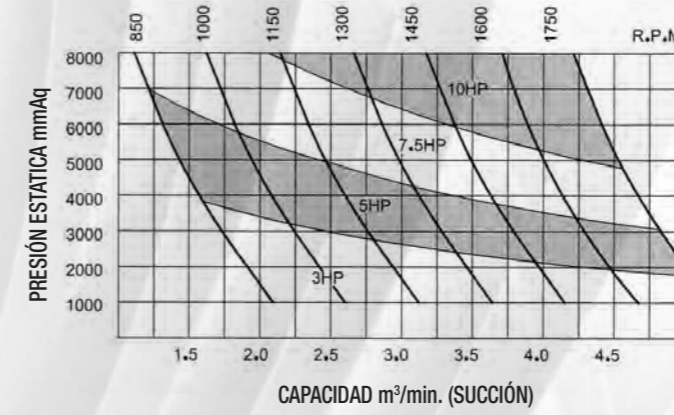

DS 1300

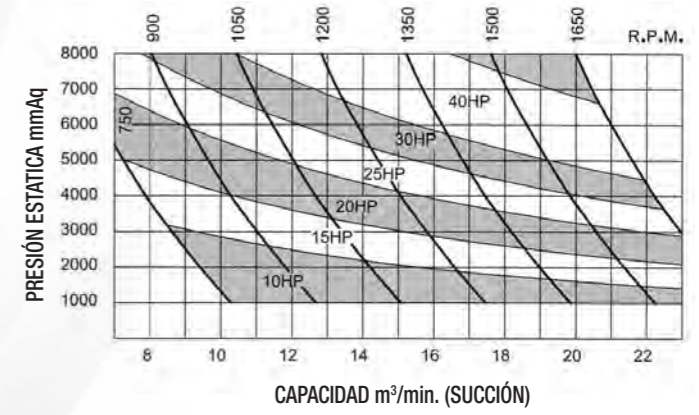

curva de rendimiento de la presión

DS 1800

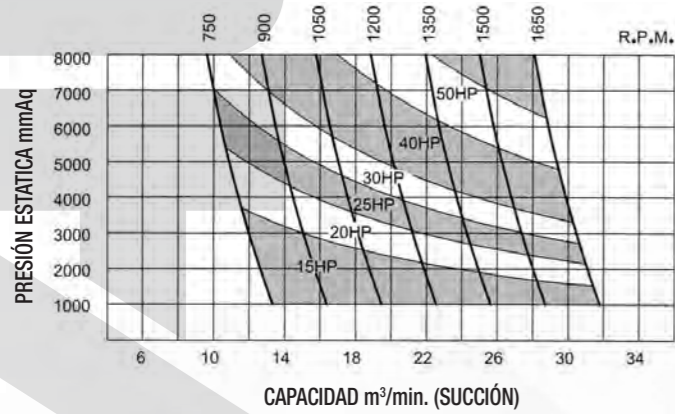

DS 9000

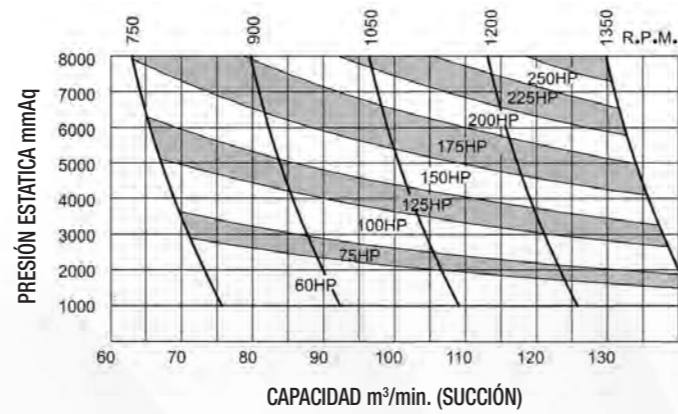

DS 2800

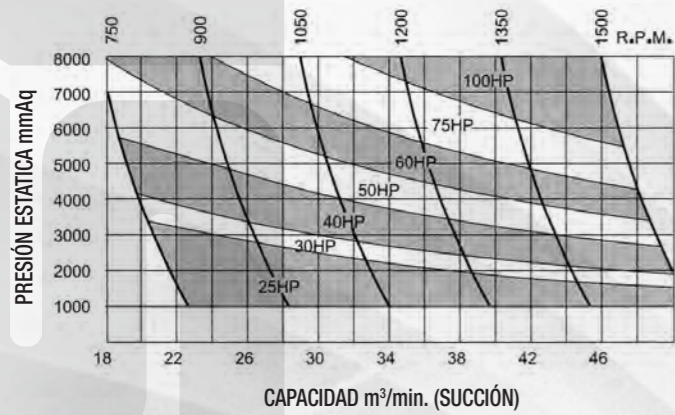

DS 17000

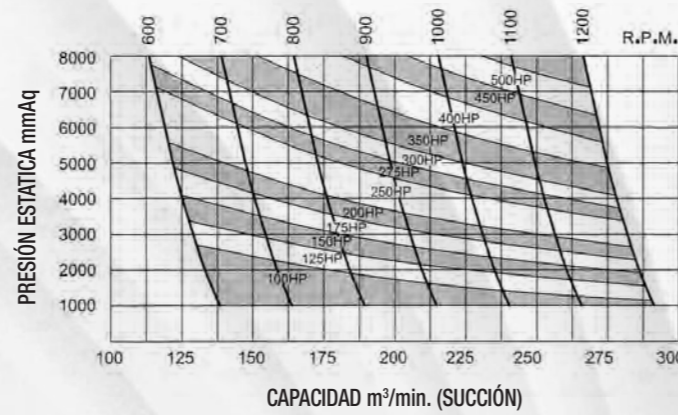

DS 4500

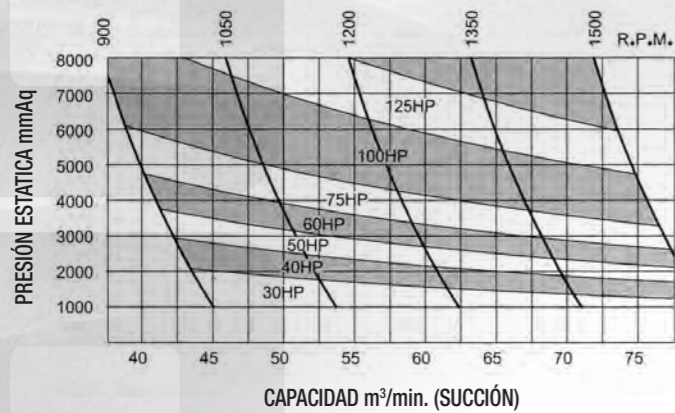

DS 22000

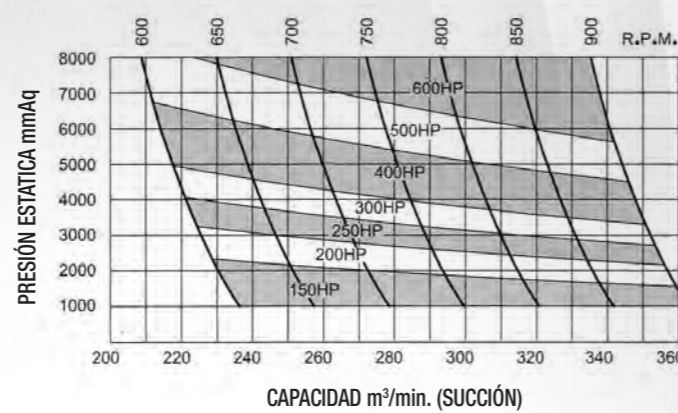

curva de rendimiento del vacío

DSV 60

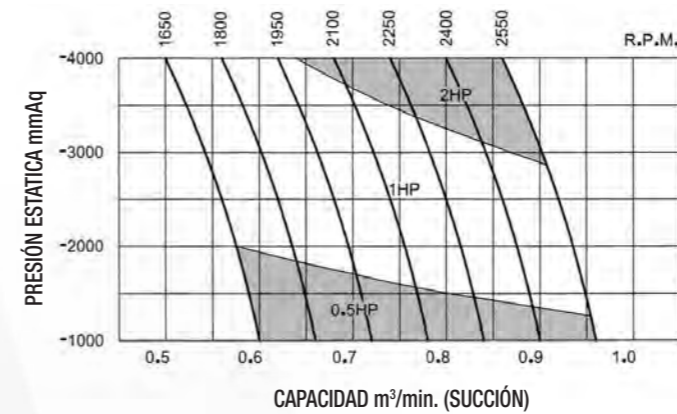

DSV 500

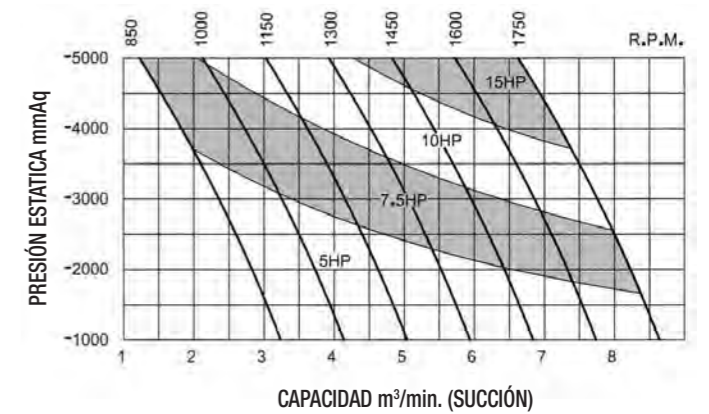

DSV 150

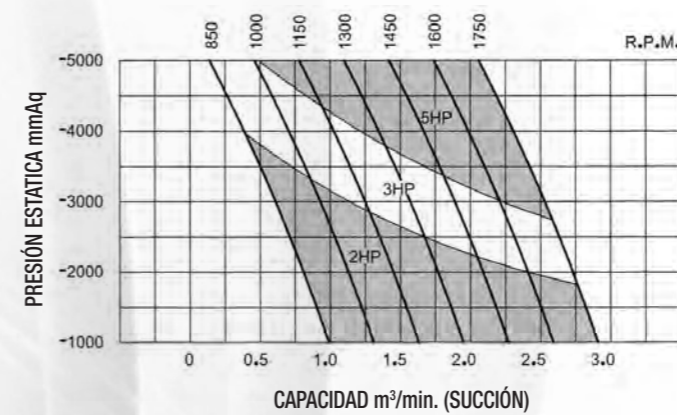

DSV 700

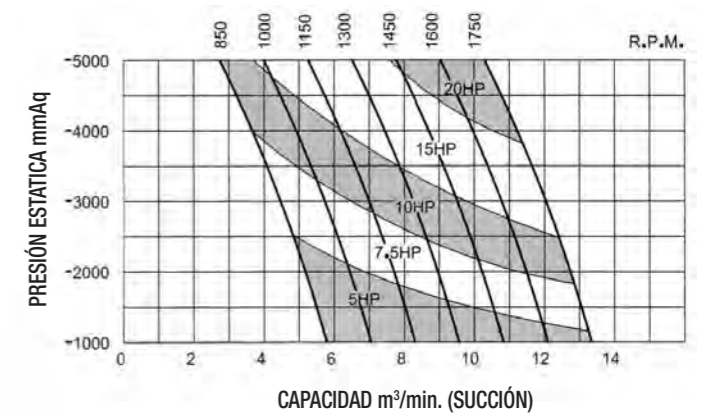

DSV 300

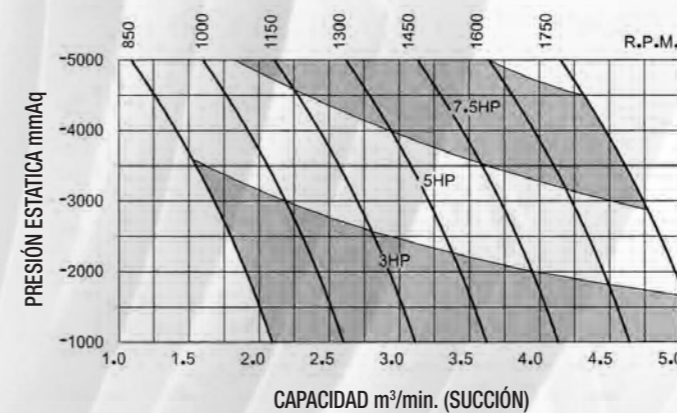

DSV 1300

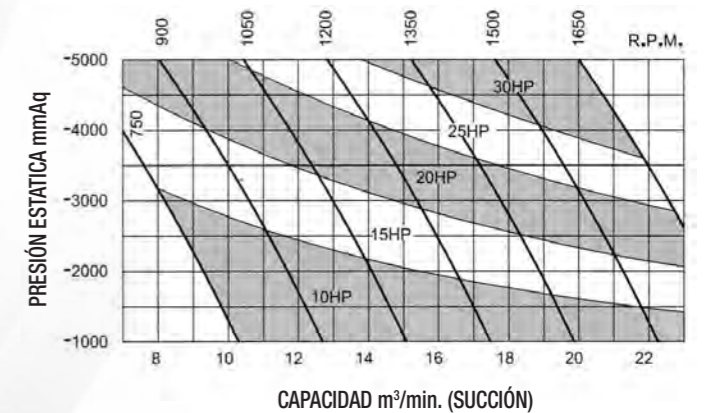

curva de rendimiento del vacío

DSV 1800

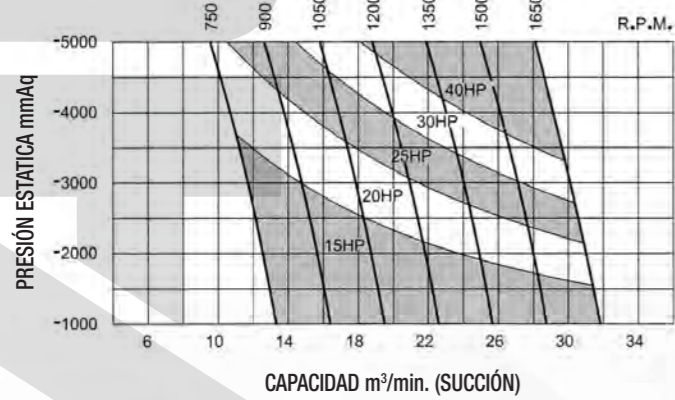

DSV 9000

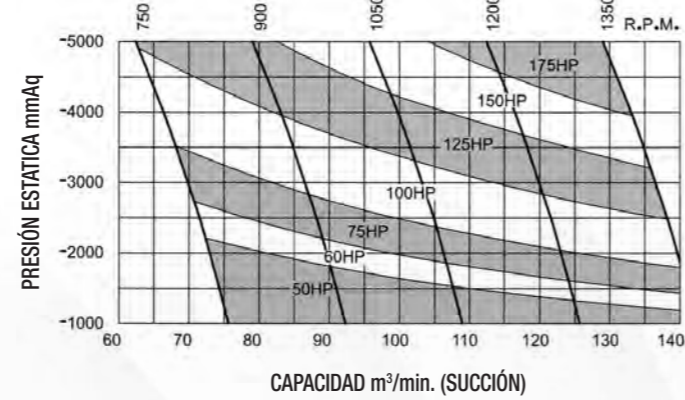

DSV 2800

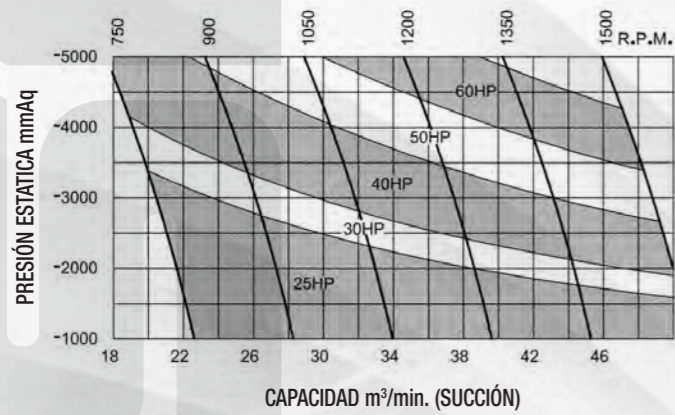

DSV 17000

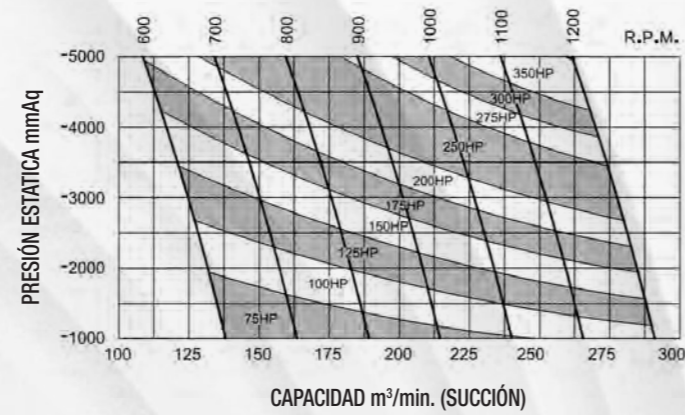

DSV 4500

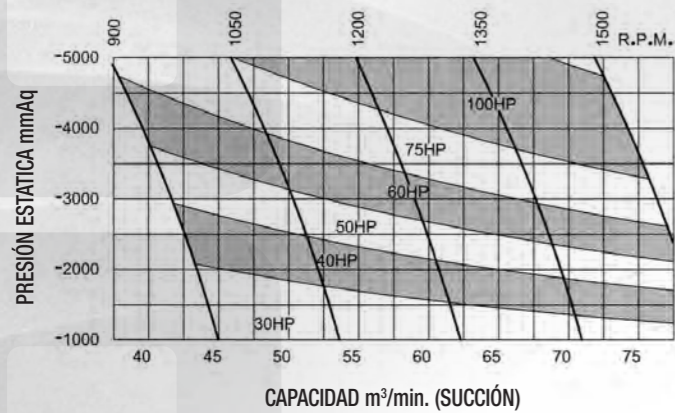

DSV 22000

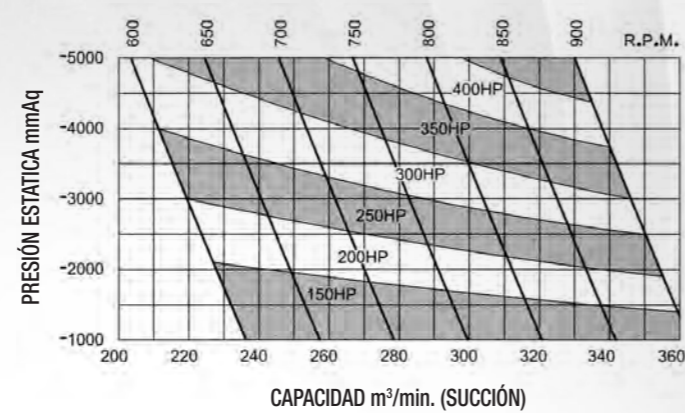

especificaciones de rendimiento de ruido

DS-DSV 60

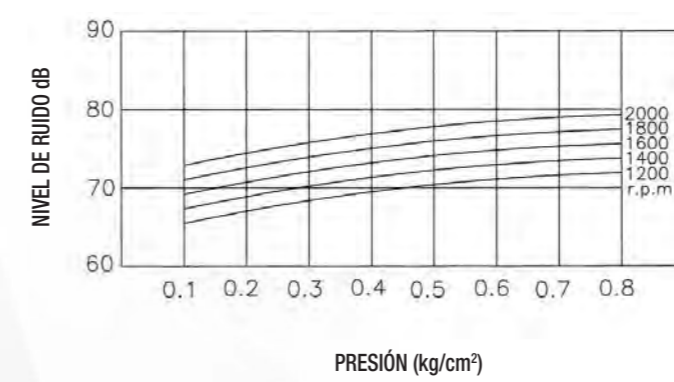

DS-DSV 500

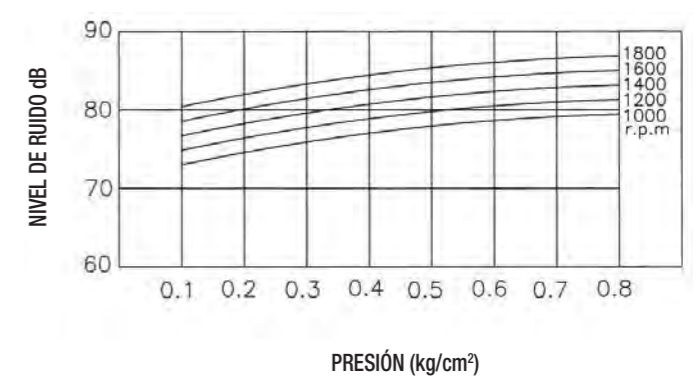

DS-DSV 150

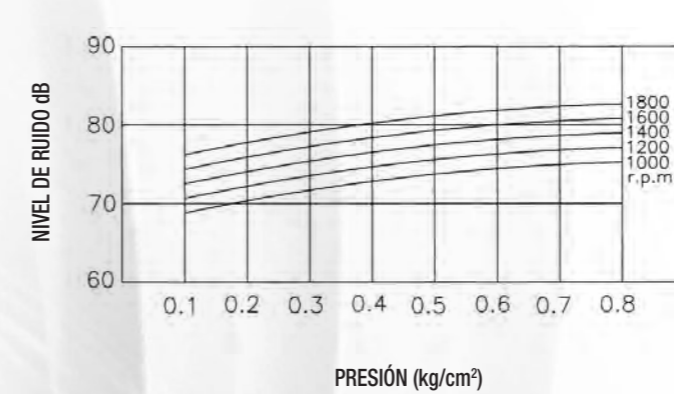

DS-DSV 700

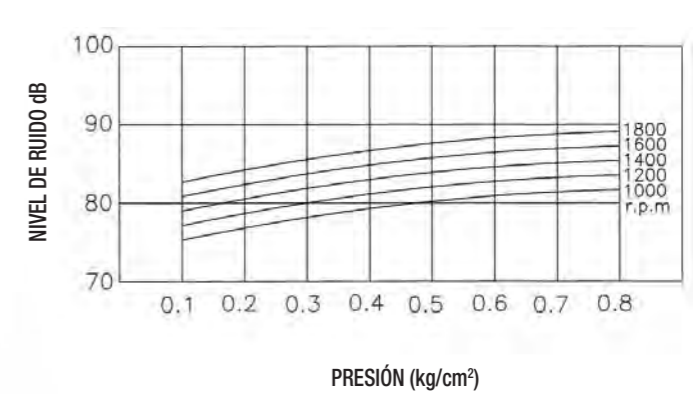

DS-DSV 300

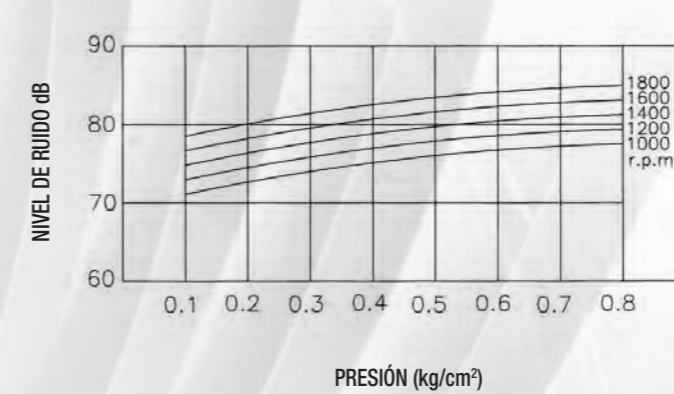

DS-DSV 1300

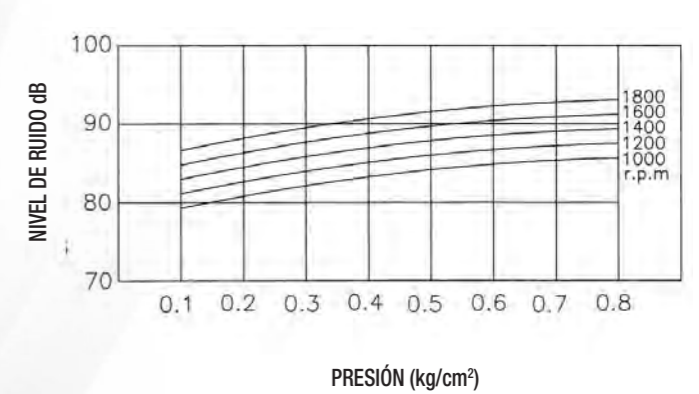

especificaciones de rendimiento de ruido

DS-DSV 1800

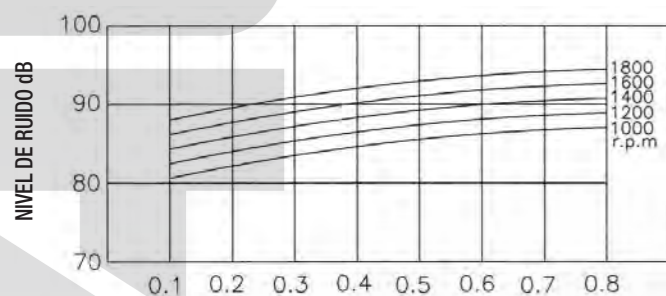

PRESIÓN (kg/cm²)

DS-DSV 9000

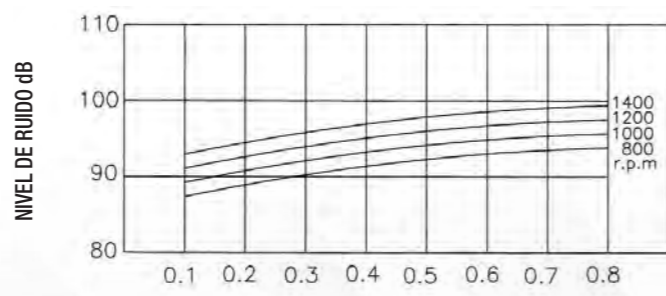

PRESIÓN (kg/cm²)

DS-DSV 2800

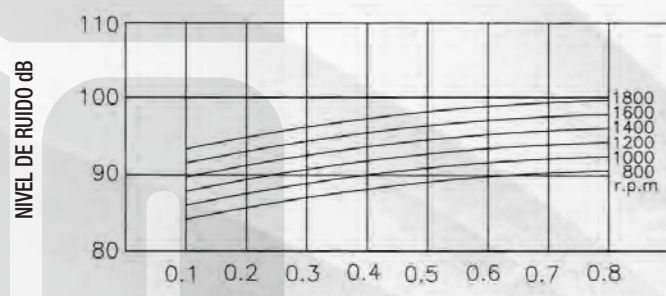

PRESIÓN (kg/cm²)

DS-DSV 17000

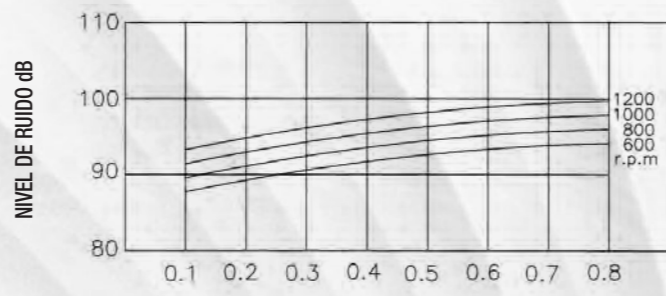

PRESIÓN (kg/cm²)

DS-DSV 4500

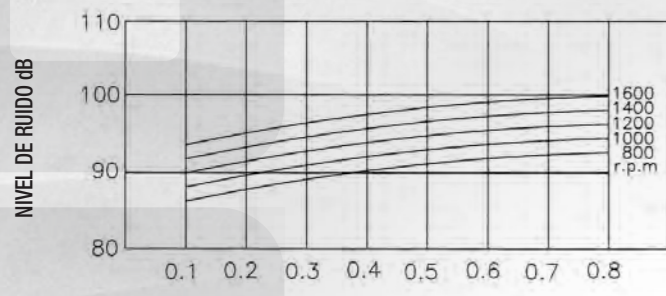

PRESIÓN (kg/cm²)

DS-DSV 22000

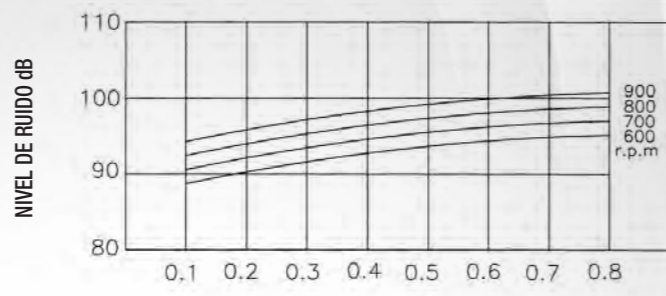

PRESIÓN (kg/cm²)

DIMENSIONES Y PESOS

DS 60

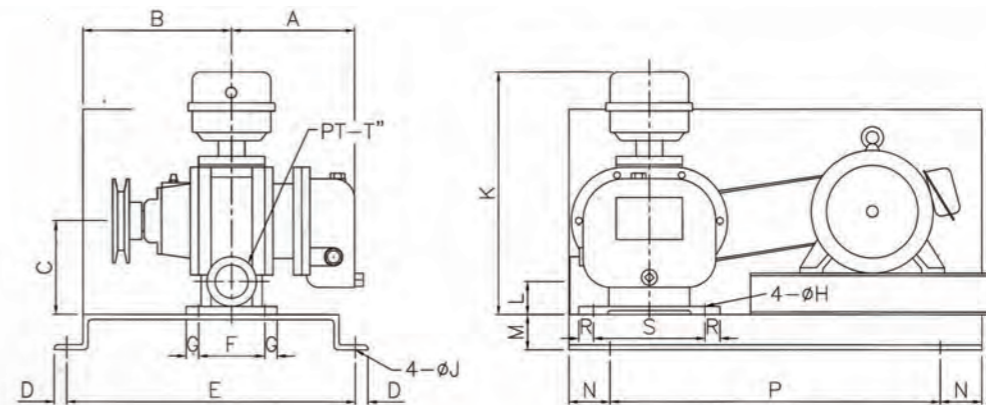

MODELO	A	B	C	D	E	F	G	H	J	K	L	M	N	P	R	S	T	Peso
DS 60	162	185	120	15	350	80	15	10	12	340	40	43	50	400	15	135	1.5	25

Dimensiones: mm / Peso: kg

DS 150/300

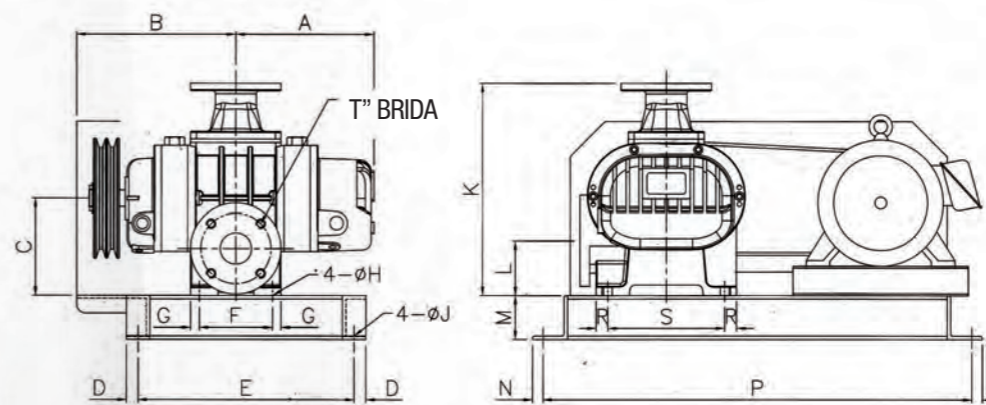

MODELO	A	B	C	D	E	F	G	H	J	K	L	M	N	P	R	S	T	Peso
DS 150	240	270	168	20	370	125	15	15	15	356	90	75	18	734	15	200	2	76
DS 300	280	290	173	20	370	210	15	15	15	356	95	75	18	734	15	200	2.5	94

Dimensiones: mm / Peso: kg

DS 500/1800

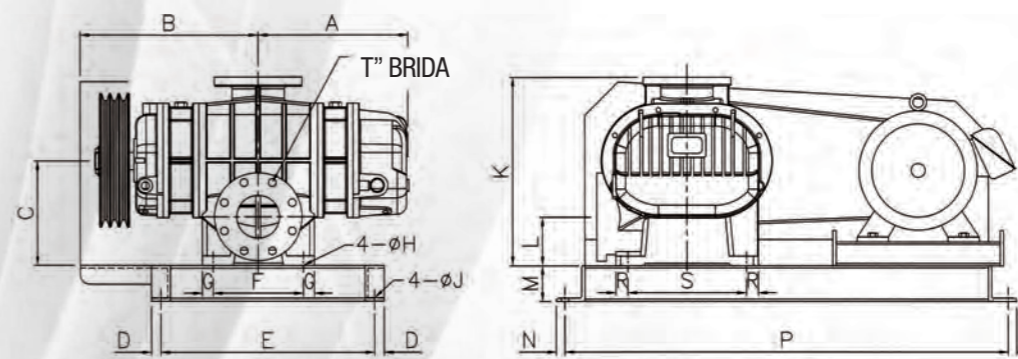

MODELO	A	B	C	D	E	F	G	H	J	K	L	M	N	P	R	S	T	Peso
DS 500	315	375	220	20	450	190	25	19	15	395	102	75	18	934	25	250	3	167
DS 700	365	425	220	20	450	290	25	19	15	395	115	75	18	934	25	250	4	193
DS 1300	445	485	300	25	605	320	25	19	19	515	155	100	20	1190	25	350	5	353
DS 1800	500	540	300	25	605	425	25	19	19	515	155	100	20	1190	25	350	6	418

Dimensiones: mm / Peso: kg